



Next Generation R-Series Oil-Flooded Rotary Screw Air Compressors



The intelligence you need to move your business forward

Ingersoll Rand works to keep you ahead of your competition with advanced compressed air systems that boost productivity, lower operating expenses and extend equipment life. These innovations are designed into every Next Generation R-Series oil-flooded rotary screw air compressor—industry-leading airend enhancements for superior efficiency, best-in-class delivered capacity and exceptional reliability. All supported by unique advantages, including expert design and engineering, a comprehensive suite of support programs and long-life Ingersoll Rand-branded consumables.

Next Generation R-Series compressors. The intelligence you need—to win.

Global presence, local service



Manufacturing sites

- Buffalo, NY USA
- Campbellsville, KY USA
- Mocksville, NC USA
- West Chester, PA USA
- Curitiba, Brazil
- Unicov, Czech Republic
- Wasquehal, France
- Oberhausen, Germany
- Fogliano, Italy
- Milan, Italy
- Vignate, Italy
- Ahmedabad, India
- Nanjing, China
- Shanghai, China
- Wujiang, China

Global distribution centers

- Charlotte, NC USA
- Genk, Belgium
- Singapore
- Shanghai, China

Efficient operation and powerful information

We started at the core

When we made the Next Generation R-Series we started with an all-new, state-of-the-art airend, making it your best choice for performance. The new airend improves efficiency as much as 13% through several advancements, including an optimized rotor profile to help minimize operating expenses. The new rotor profile also provides world-class airflow delivering up to 11% more airflow than previous models. With more airflow for the same power input, your compressor requirements are smaller, reducing both investment costs and energy usage, to lower your total cost of ownership.



Knowledge is power

The best compressors deliver air and actionable information. That's why every Next Generation R-Series compressor includes an Xe-Series intelligent controller that monitors key operations and adjusts system parameters to maximize uptime and minimize energy consumption. It gives you real-time facts to make and execute informed decisions. . .from virtually anywhere in the world.



Driving toward maximum efficiency

Every Next Generation R-Series compressor's drive motor features an advanced induction design that meets the IE3 energy-efficiency standards. For even more efficiency, an optional variable speed drive (VSD) can help you save up to 35% on energy costs.

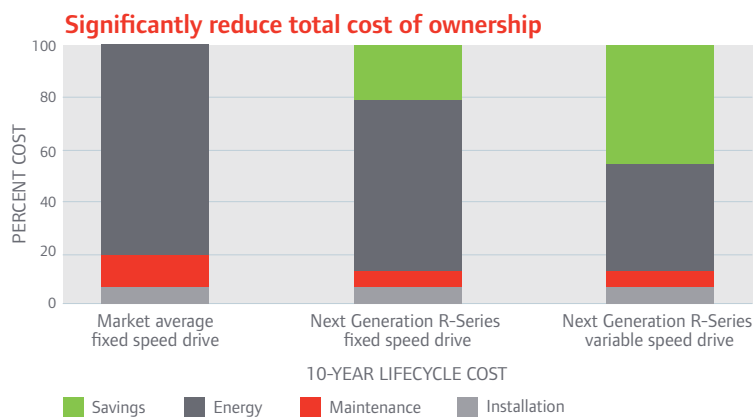
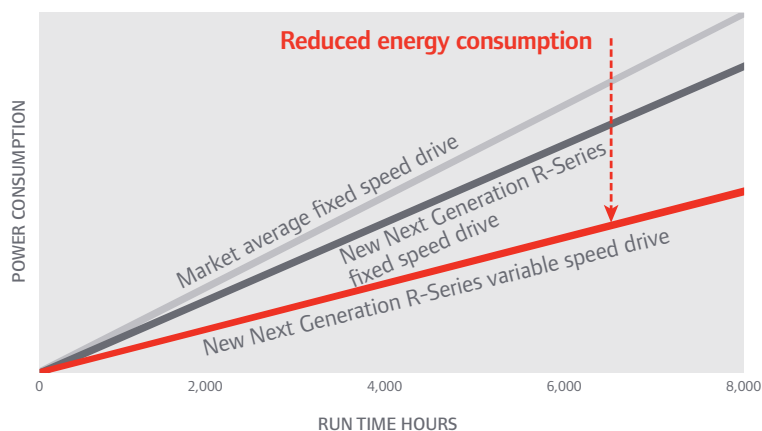

Rotary comparison at 79% average volume capacity, 4,000 hours per year, 0.1€/kWh

The elements of smart design

INTELLIGENT



- 1 Xe-Series intelligent controllers** monitor and adjust system parameters and can email you when operational events occur—so you can take action, accessing the compressor system from any current, common web browser in the world

- 2 Progressive Adaptive Control (PAC™)** automatically reacts to key parameters to minimize unexpected downtime
- 3 Hinged-door service access with integrated handles** provides quick, easy access to all user-maintainable components—including the heat exchangers, which don't require removal during routine cleaning

RELIABLE

- 4 Three-stage separation system with conical baffle** removes all but 3 ppm of lubricating oil from delivered air—protecting downstream equipment and extending filter life—to maximize productivity and minimize expenses (available on “ie” compressor models only)

- 5 Long-life Ingersoll Rand consumables** reduce hard costs, extend maintenance intervals and minimize downtime
- 6 Free-floating cooling system** allows heat exchangers to expand and contract, reducing thermal stress for improved durability



Electronic, no-loss drain valves allow condensate draining without the loss of air pressure, saving you money



EFFICIENT



- 7 **All-new, state-of-the-art air end** improves efficiency as much as 13% and is designed for 10 years* of reliable operation

- 8 **V-Shield™ technology** uses a combination of advanced techniques that help deliver repeatable, leak-free connections
- 9 **IE3 motors** deliver even more energy savings than high-efficiency motors, and an available variable speed drive (VSD) helps further decrease energy demands

ALL-IN-ONE



- 10 **Total Air System (TAS) package** is available to complete your air compressor system with a space-saving, ready-to-run, pre-mounted dryer and filters
- 11 **Patented three-in-one modular cross-flow heat exchanger** economically repurposes compressor heat to support other heat-dependent processes

- 13 **Single-location connectors** consolidate electrical, air and condensate drain systems for faster, less expensive installations

- 12 **Two-stage, high-efficiency air filters** deliver exceptional filtration, maintain maximum airflow and provide a visual indicator when changing is required

*Based on 4,000 operating hours annually

The airend—the heart of every compressor



Air compressor use accounts for a significant part of your business's energy costs. Our engineers and design experts used advanced computer modeling techniques to create a superior airend that improves efficiency up to 13%—plus best-in-class airflow capacity, quieter operation and a longer, more reliable life: multiple advantages to improve your business's bottom line.

Designed to deliver 10 years of reliable operation

- 1 **Strategically positioned lubrication points** efficiently deliver oil exactly where it's needed, improving reliability and lowering power consumption
- 2 **Advanced gear design** transmits drive power more efficiently and reliably

INTEGRAL GEARBOX

- 3 **Integral gearbox** reduces windage losses and drivetrain length for more efficient performance and easier serviceability
- 4 **Enhanced bearing arrangement** reduces resistance and improves power management for maximum reliability and performance
- 5 **Maintenance-free, sealed drive system** requires no regular service and protects against damaging dirt and moisture

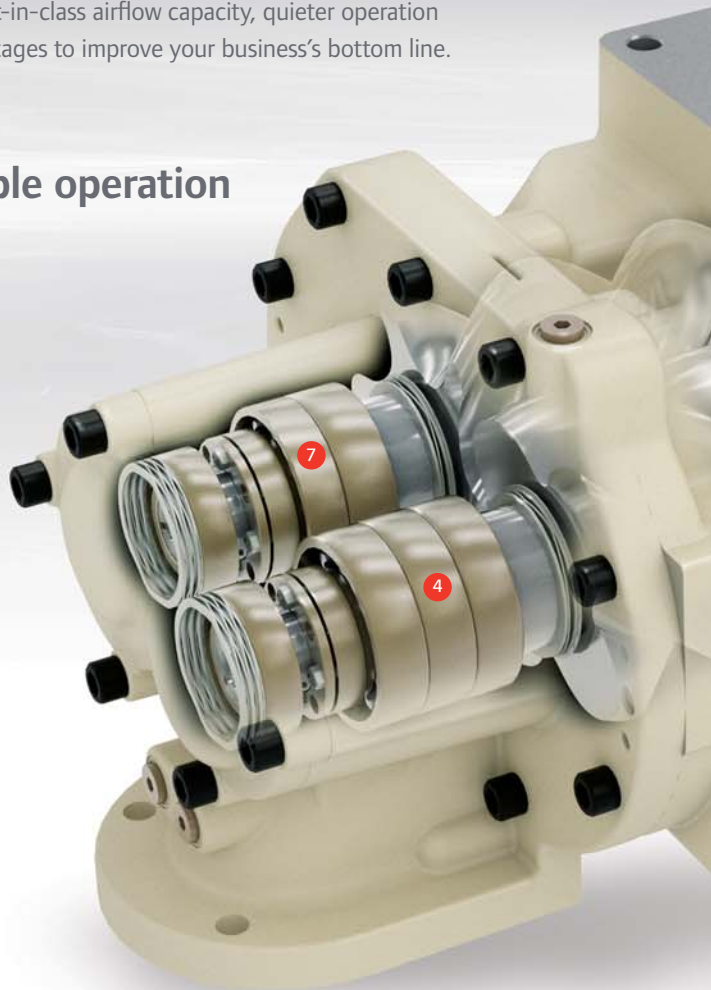

Maximum change intervals, maximum protection

Get the best of both worlds. Ingersoll Rand filters and lubricating oils provide unsurpassed longevity and protection to keep your Next Generation R-Series compressor running longer.

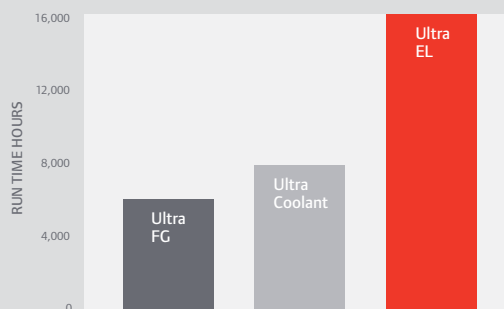

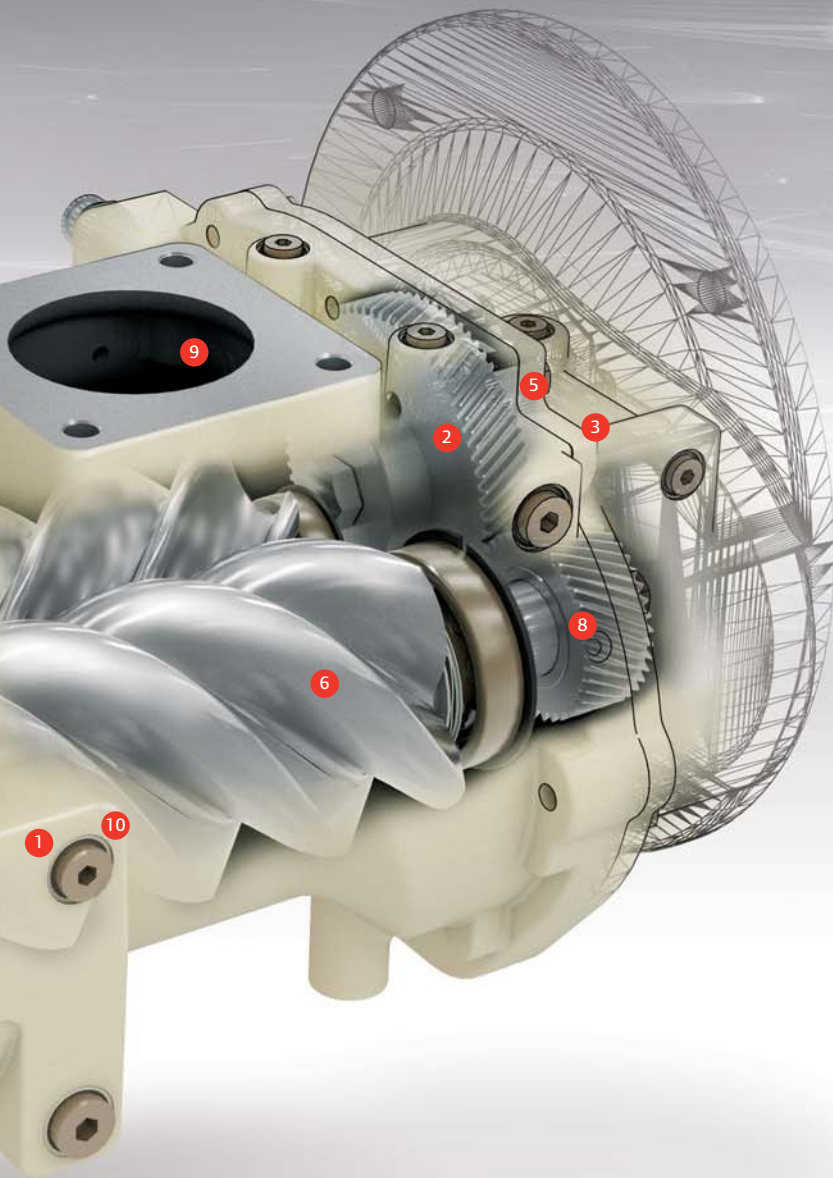

World-class energy efficiency

ADVANCED ROTOR PROFILE

- 6 **Optimized rotor profile** helps deliver superior energy efficiency—up to 13% more
- 7 **Lower friction bearing arrangements** improve energy efficiency
- 8 **Optimized gear lubrication** increases reliability and reduces power consumption through strategically injecting oil into gear mesh
- 9 **Streamlined inlet and outlet flow passage** reduces pressure drops
- 10 **Optimized oil-injection process** lowers temperature and increases efficiency during compression

World-class delivered capacity

The Next Generation R-Series has a new rotor profile that delivers up to 11% more airflow, surpassing the capacity of similarly sized systems. Get the airflow you need—and save on operating costs as well—from a smaller, less expensive, more-efficient Next Generation R-Series system.

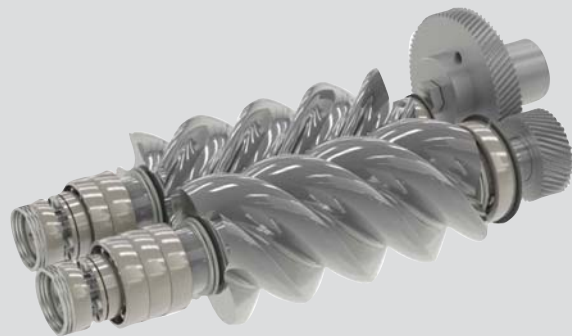

Reliable air to keep you running

Every component in a Next Generation R-Series compressor system supports maximum reliability—for more productivity, longer equipment life, lower operating costs and higher profitability.

Progressive Adaptive Control (PAC™)

PAC helps you properly maintain your air compressor system by automatically reacting to key parameters to reduce the risk of unexpected downtime.

- Monitors critical performance parameters
- Adjusts system output to address extreme conditions and ensure continued operation without damaging the system—even when certain maintenance operations are overdue

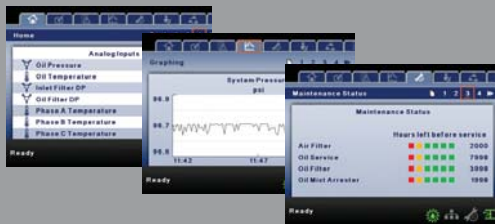

Free-floating cooling system

Allows heat exchangers to expand and contract, reducing thermal stress for improved system durability.

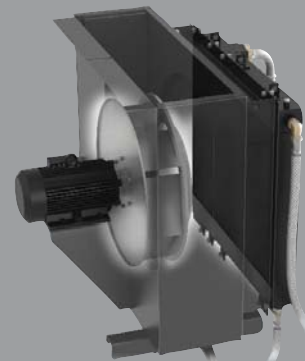

V-Shield™ technology

V-Shield™ technology combines superior techniques that deliver repeatable, leak-free connections to maximize efficiency and reduce leak-related problems.

- **Face-seal connections** provide flat, tight, virtually distortion-free joints
- **Fluoroelastomer O-rings** resist chemicals and extreme temperatures for long-term durability
- **Premium metal-flex air hoses** last up to three times longer than conventional hoses, using a braided stainless steel exterior and a PTFE-lined interior to resist chemicals, heat, oxidation, abrasion, pressure and fatigue
- **Vibration isolation system** reduces vibration to increase compressor life and lower noise levels



The power of intelligence

Xe-Series intelligent controllers optimize operational parameters to ensure maximum productivity. You can stay informed of the system's status and make changes from anywhere in the world.

- **Intuitive, high-resolution color display** provides easy-to-understand icons and more than 30 available languages to show vital functions at a glance
- **User-intuitive folders** with critical and non-critical parameters and operating characteristics provide deeper insights into your compressor's performance
- **Advanced control algorithms** ensure maximum energy efficiency and reliability—even during periods of moderate workloads
- **Performance analysis/graphical trending** using the Xe-145 intelligent controller to display compressor performance over time in easy-to-understand graphical charts—supporting informed decisions and well-planned maintenance
- **Integral sequencer** coordinates the operation of up to four compressors to precisely meet demand, save energy and minimize wear
- **Real-time clock schedule (option)** lets you program Xe-90/145 controllers to start/stop the system at specific times to maximize productivity, conserve energy and reduce downtime
- **On-board web pages** feature the same convenient status bar found on the controller interface



Stay connected virtually anywhere

Whether you're 1 meter or 10,000 kilometers away, Xe-Series controllers keep you connected—so you'll always know the compressor's operating status and can make any necessary changes. Onsite, connect locally through your Distributed Control System (DCS) using Modbus or Ethernet. Remotely, access critical data and controls with any common, current web browser.

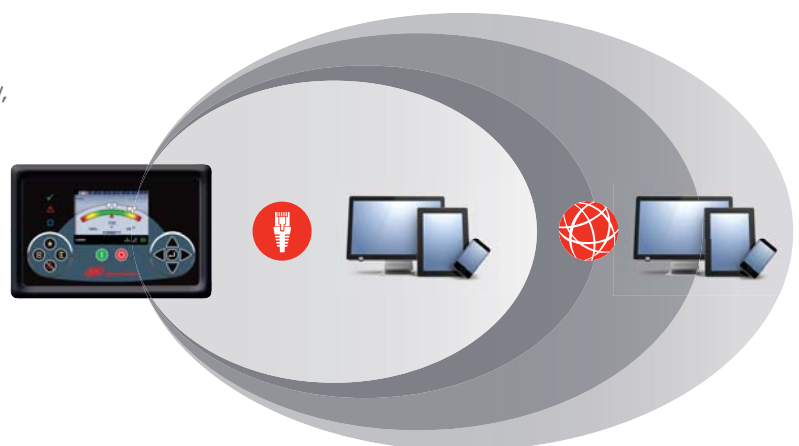

The performance you expect

Advanced solutions that ensure reliable flow—even in extreme operating environments. That's what you expect from Ingersoll Rand. That's what you get from the Next Generation R-Series.

Built to work in virtually any environment

The Next Generation R-Series features an advanced motor design built to operate at extreme ambient temperatures between 2°C and 46°C. Ambient temperatures that approach or drop below freezing can cause problems for any air compressor. The Xe-Series controller triggers an alert if freezing conditions are detected during startup.

High ambient temperature option helps deliver reliable performance, even in temperatures of up to 55°C.

Low ambient temperature option protects the system in freezing conditions with strategically placed heating elements, operating in temperatures as low as -10°C.

Outdoor option (IPX2) allows Next Generation R-Series compressors to be exposed to inclement weather, limiting water ingress and protecting sensitive electrical areas.

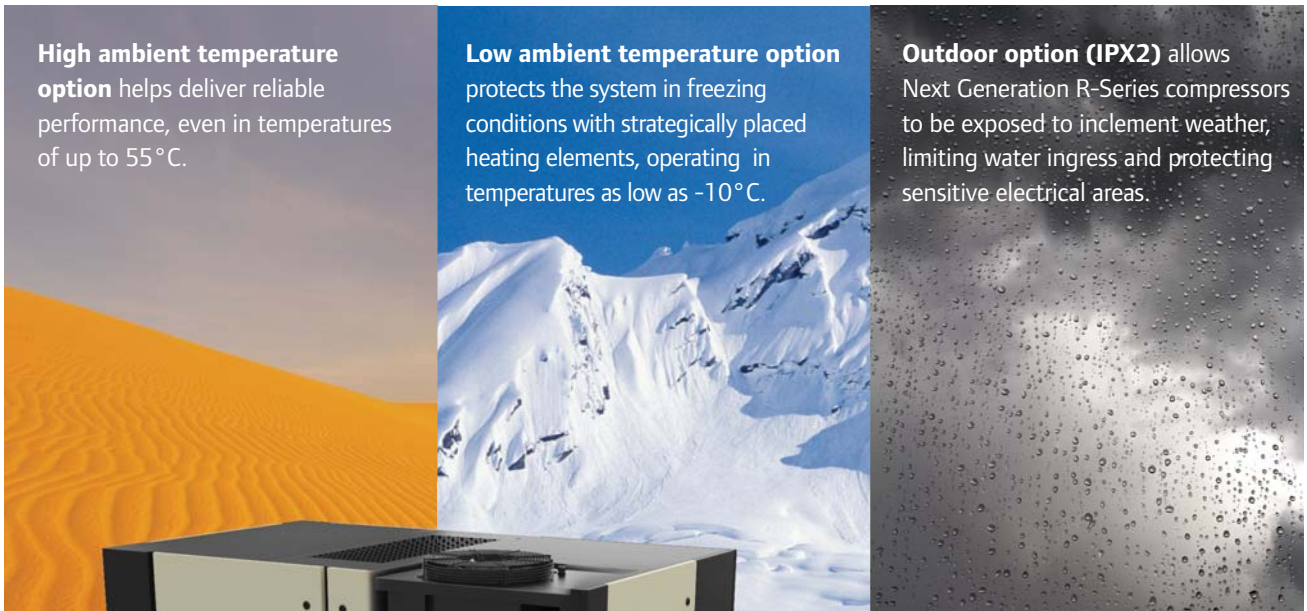

Space-saving convenience

The compact Total Air System (TAS) package option delivers ISO Class 1-4-2 quality air*.

*Measured at steady state conditions in accordance with ISO 8573-1:2010, with inlet air to package conditions of 25°C and RH of 60%.

CARE. Your trusted partner in compressed air

Optimize your total **Cost** of ownership, while maximizing **Availability, Reliability** and **Efficiency** throughout the life of your compressed air system with our Lifecycle CARE services.

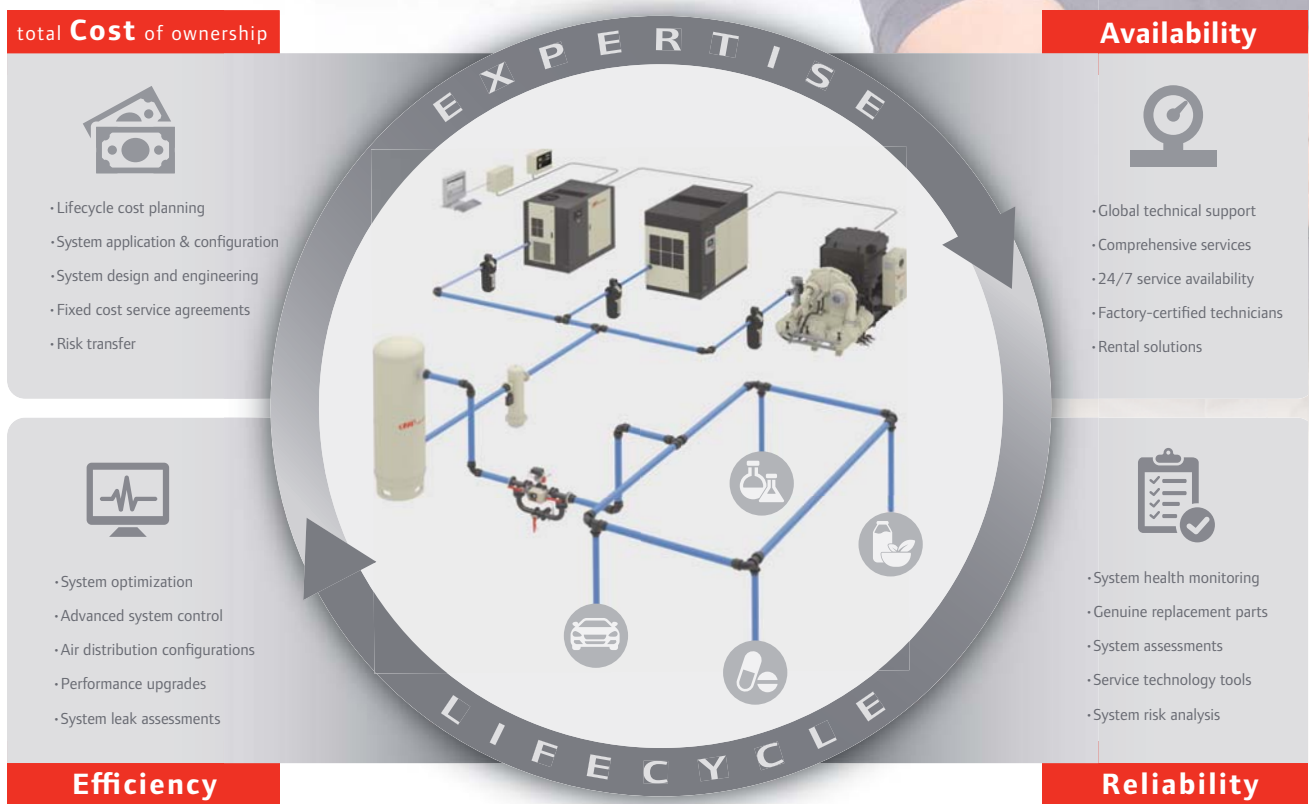
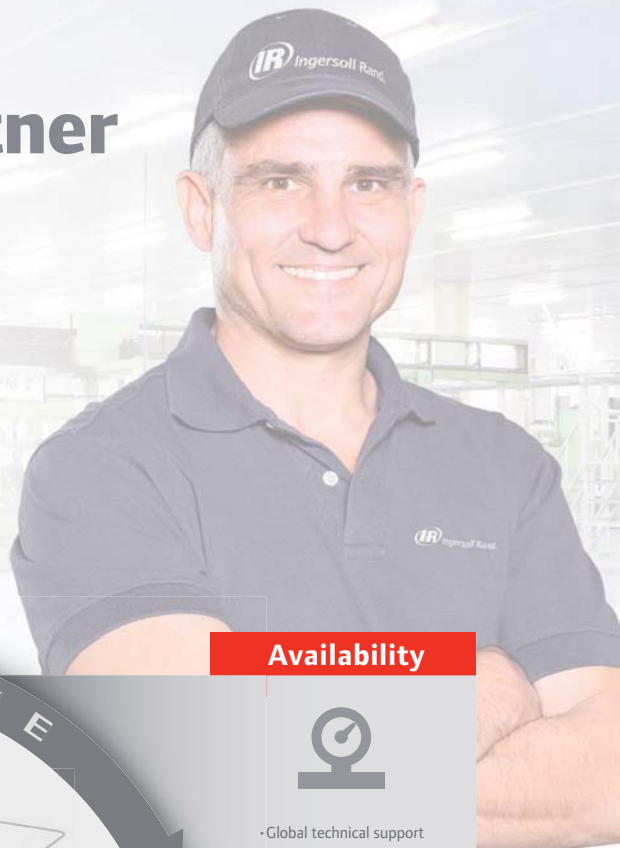

Design • Install • Commission • Operate • Maintain • Extend





Ingersoll Rand (NYSE:IR) advances the quality of life by creating comfortable, sustainable and efficient environments. Our people and our family of brands—including Club Car®, Ingersoll Rand®, Thermo King® and Trane®—work together to enhance the quality and comfort of air in homes and buildings; transport and protect food and perishables; and increase industrial productivity and efficiency. We are a \$13 billion global business committed to a world of sustainable progress and enduring results.



www.ingersollrandproducts.com

Distributed by:



Ingersoll Rand, IR, the IR logo, PAC PackageCARE and V-Shield are trademarks of Ingersoll Rand, its subsidiaries and/or affiliates. All other trademarks are the property of their respective owners.

Ingersoll Rand compressors are not designed, intended or approved for breathing air applications. Ingersoll Rand does not approve specialized equipment for breathing air applications and assumes no responsibility or liability for compressors used for breathing air service.

Nothing contained on these pages is intended to extend any warranty or representation, expressed or implied, regarding the product described herein. Any such warranties or other terms and conditions of sale of products shall be in accordance with Ingersoll Rand's standard terms and conditions of sale for such products, which are available upon request.

Product improvement is a continuing goal at Ingersoll Rand. Designs and specifications are subject to change without notice or obligation.